

ELFÖRBINDNINGSSCHEMA SYSTEM 4:2, 1-FAS

0943

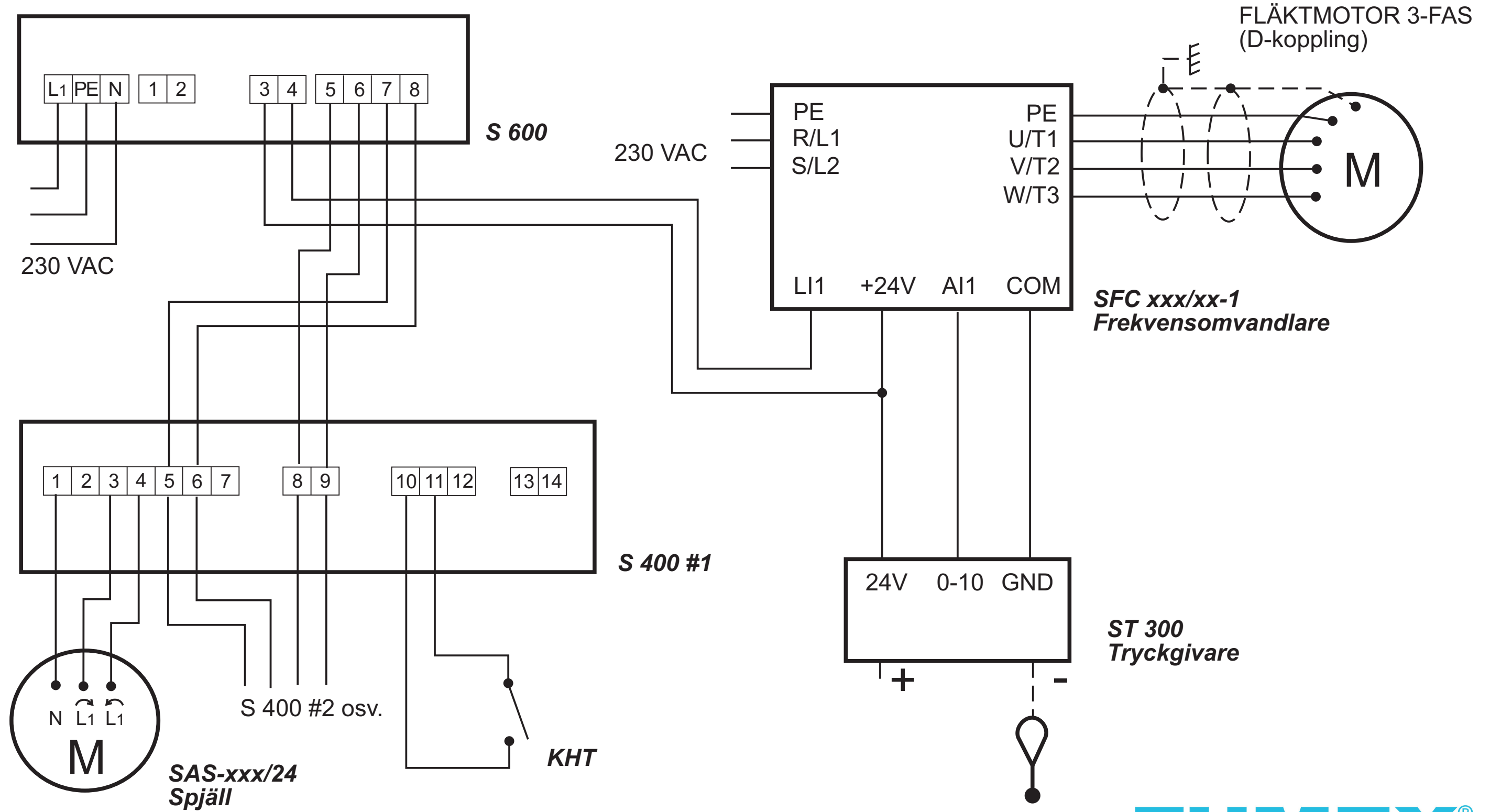

CONNECTION DRAWING SYSTEM 4:2, 1-PHASE

0943

