

ELFÖRBINDNINGSSCHEMA SYSTEM 4:12

1647

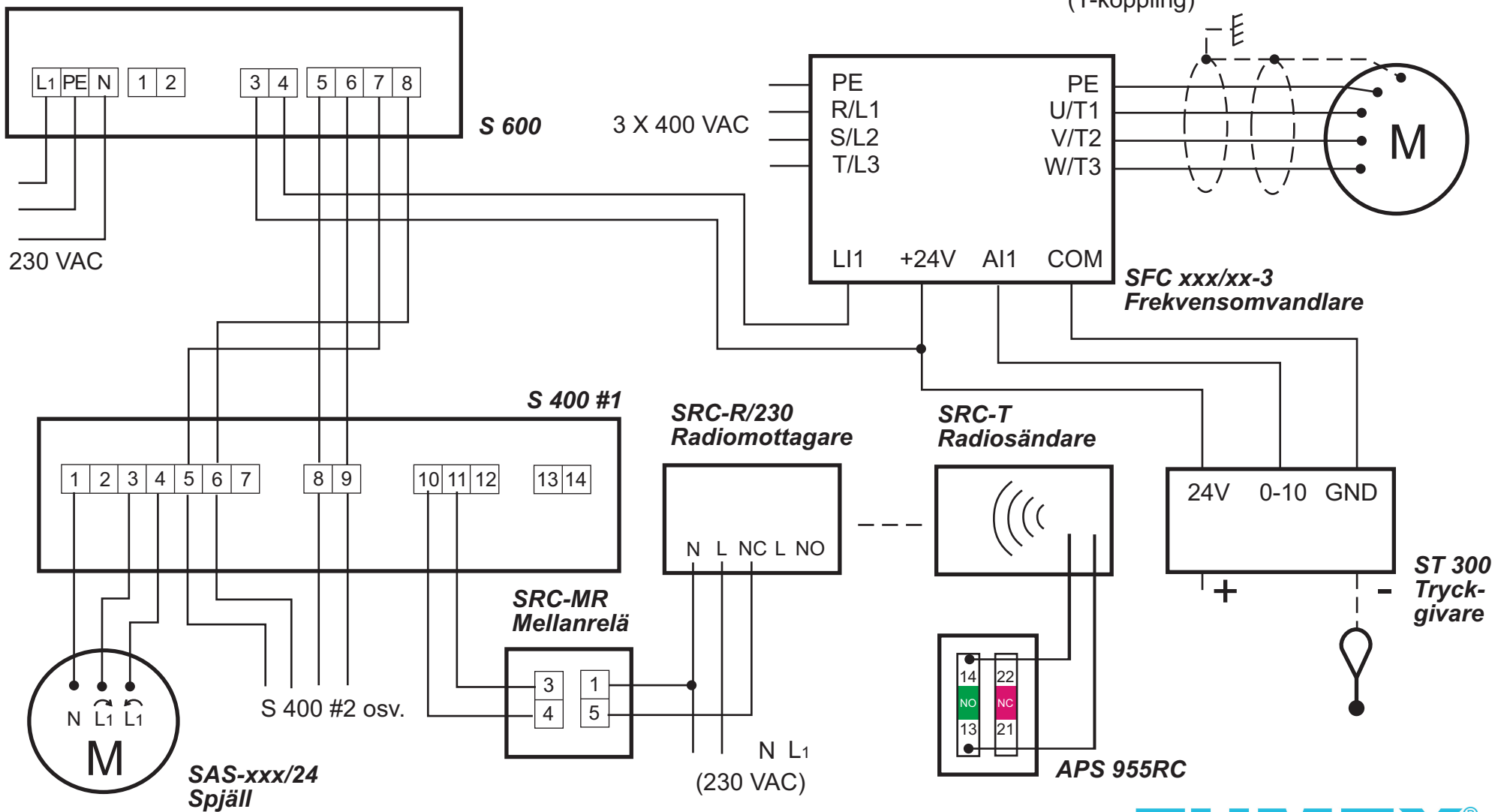

CONNECTION DRAWING SYSTEM 4:12

1647

