

ELFÖRBINDNINGSSCHEMA SYSTEM 3:2

0943

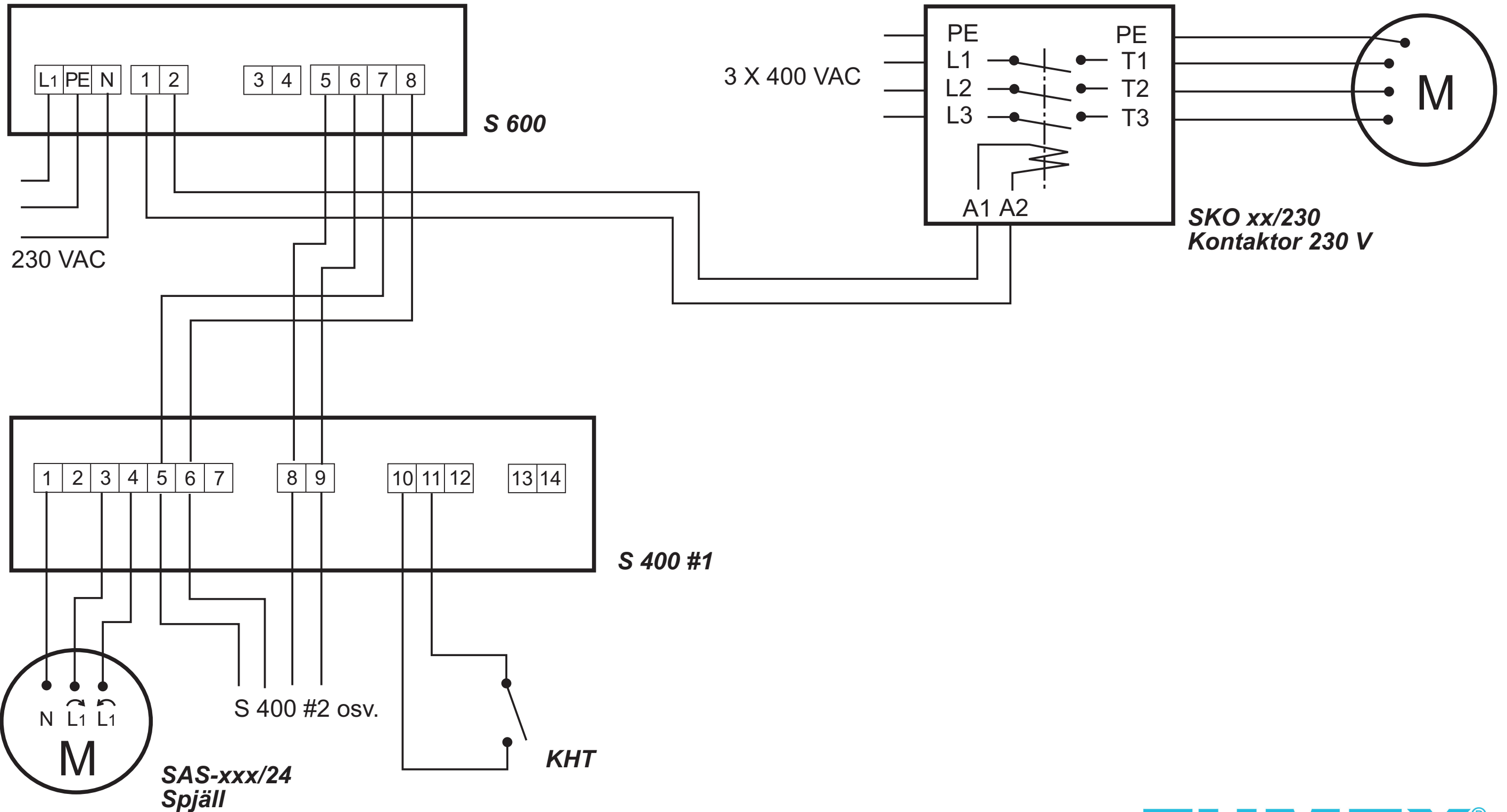

CONNECTION DRAWING SYSTEM 3:2

0943

