

FUMEX®

LF

Portable filter with numerous areas of use and flexible solutions for temporary work.

Fumex LF is an effective and flexible solution including a fan and filter in a single unit.

LF includes a FF 100 fan with a highly-efficient EC motor, equipped with speed control as well as a filter. The filter comes in two designs and in two sizes - combined particle/gas filter or gas filter.

LF is available as a complete kit solution, in six designs for simple selection and installation.

The FF 100 fan can be used separately e.g. in combination with Fumex series laboratory extractors.



The Fumex range also includes fans, accessories, automatic controls and filters suitable for local extraction.

MOBILE FILTER
Pure advantages

FUMEX® LF

Complete LFK kits for flexible solutions and simple installation.

All kits come complete with hoses, connectors and accessories. Each arm is equipped with a damper for individual airflow adjustment. The FF 100 fan has an EC motor with potentiometer for speed control, which makes it easy to continuously adjust the ventilation according to airflow requirements.

LFK 150

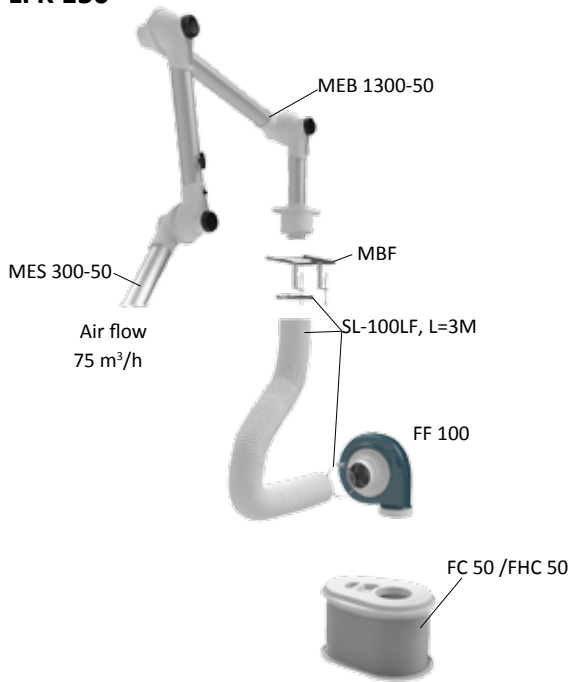

LFK 250

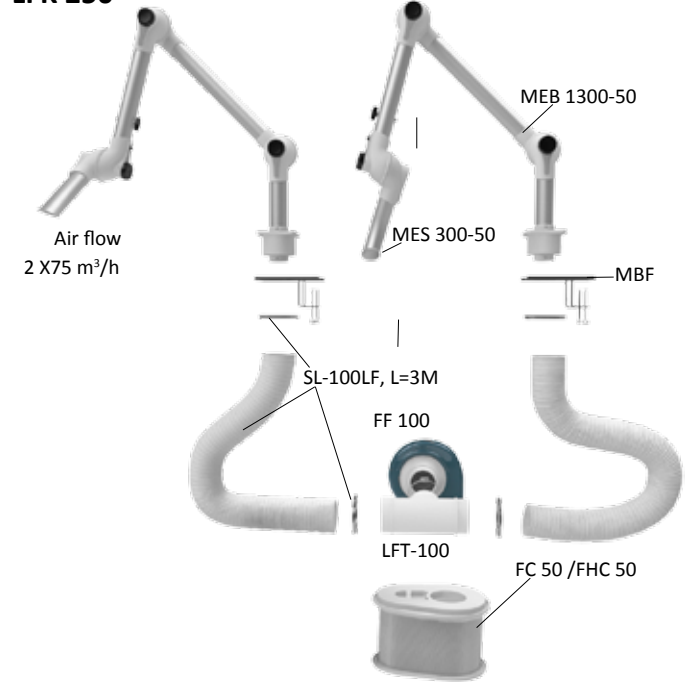

LFK 450

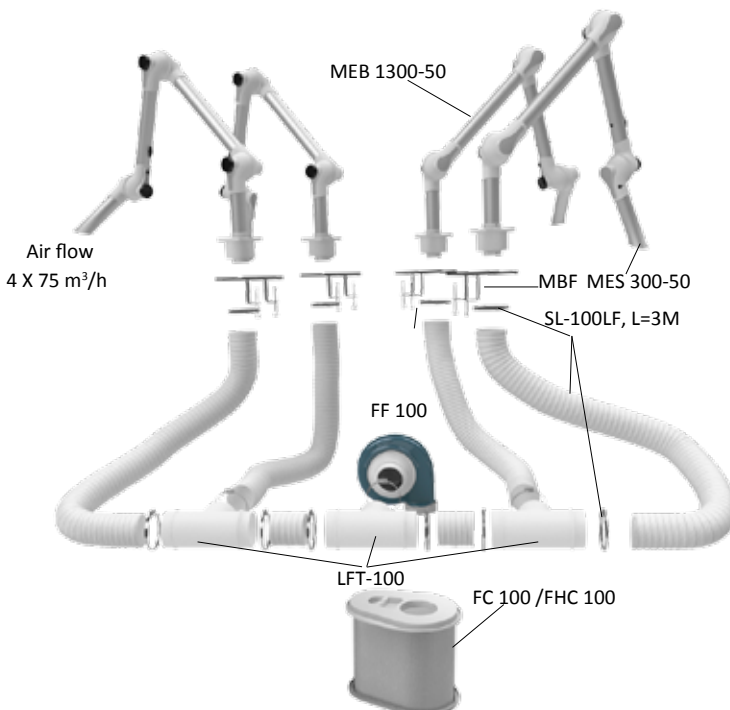

LFK 350C

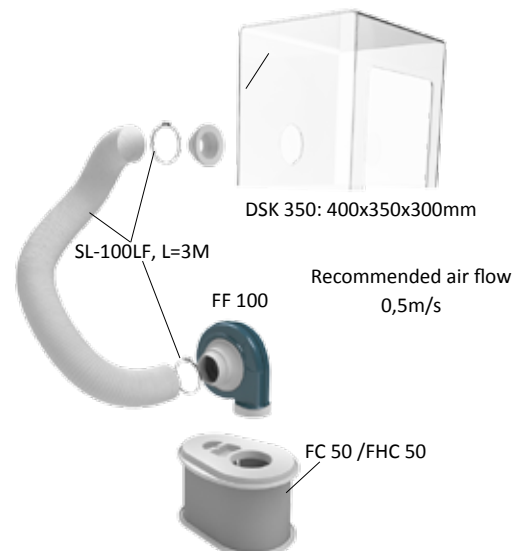

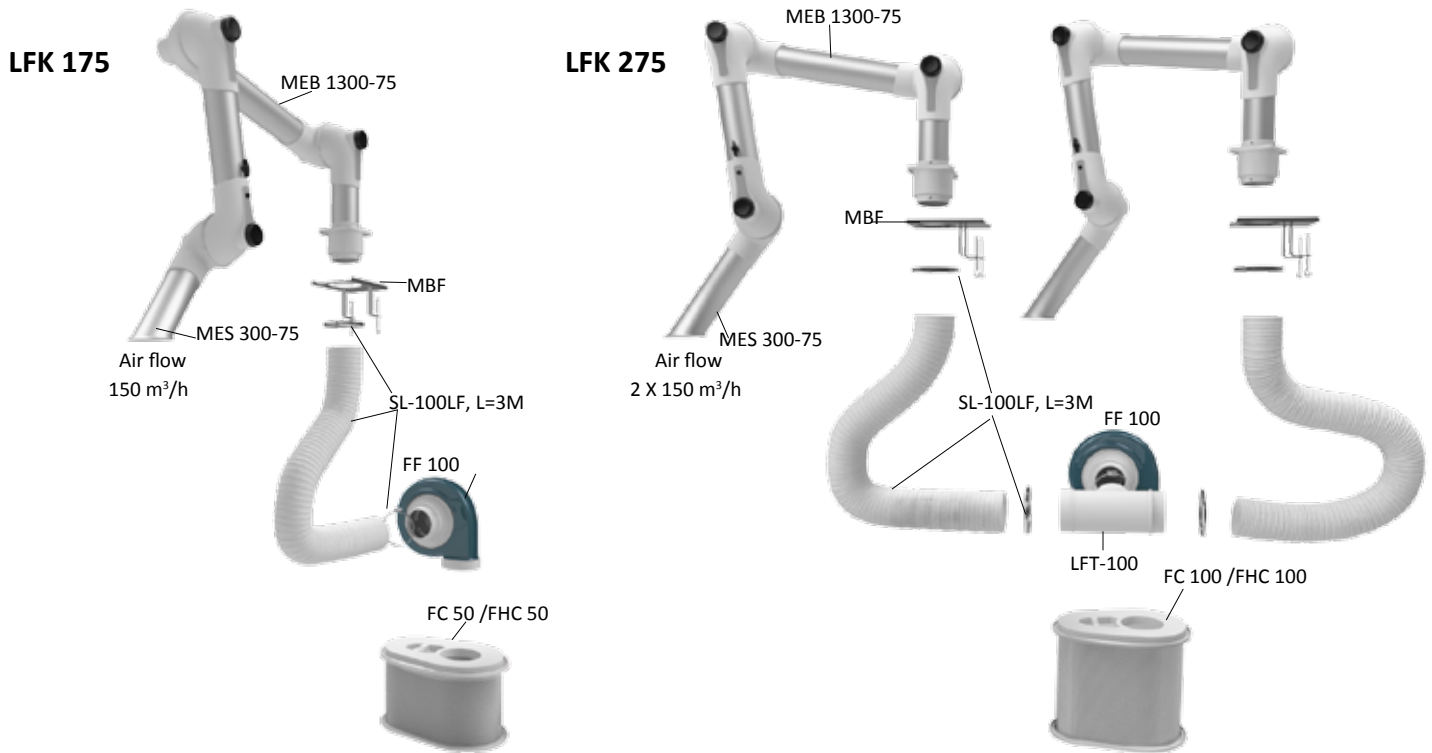

Our LFK kits contain ME arms with low pressure drop and high flexibility

Lowest possible pressure drop is a quality aspect that always should be considered.

With its uniquely designed joint construction, Fumex ME combines maximum flexibility with low pressure drop. The air passes through the joints without creating unnecessary turbulence, thus producing an energy-saving low pressure drop and a quieter working environment.





SPEED CONTROL FAN

Part.nr: **FF 100/230**

Part.nr: **FF 100/115**

The efficient EC motor with integrated speed control allows for variable airflow. The fan's optimized design provides superior performance with maximum pressure. Connects easily to single-phase electrical connectors. Can also be used as a separate unit in combination with wall-bracket LF VK and Fumex series laboratory arms. FF 100 available for 200-240V, 50-60Hz or 100-130V, 50-60Hz.



PORTABLE FILTER UNIT WITH FAN

Part.nr: **LF 50PG/230** Particle/Gas filter

Part.nr: **LF 50G/230** Gas filter

Part.nr: **LF 50PG/115** Particle/Gas filter

Part.nr: **LF 50G/115** Gas filter

Part.nr: **LF 100PG/230** Particle/Gas filter

Part.nr: **LF 100G/230** Gas filter

Part.nr: **LF 100PG/115** Particle/Gas filter

Part.nr: **LF 100G/115** Gas filter

A portable filter with an LF 100 fan that produces a low noise level and allows for variable airflow. The filter is either a Particle/Gas filter or solely a Gas filter and can be easily adapted according to your needs.



PARTICLE/GAS FILTER

Part.nr: **FHC 50**

Part.nr: **FHC 100**

A two stage filter that separates dust and fume particles with the initial HEPA section. This is followed by a Activated Carbon filter for absorption of VOCs, gases and odours.

FHC 50 Hepafilter/H 13* Gas filter/Activated carbon filter 2 kg

FHC 100 Hepafilter/H 13* Gas filter/Activated carbon 4 kg

**Filter efficiency for a H13 filter is 99.99% for 0.3 µm particles*



GAS FILTER

Part.nr: **FC 50**

Part.nr: **FC 100**

A high capacity filter for applications needing gas filtration only. The high quality granulated activated carbon is suitable for the absorption of VOCs, gases and odours.

FC 50 Gas filter / 6,5 kg

FC 100 Gas filter / 15 kg

Accessories

BRACKET

Part.nr:

LF VK

Compatible with the FF 100 fan, for wall or ceiling mounting.



VTA ADAPTOR

Part.nr:

LF VTA

A specially designed sleeve to enable the filtered air to be vented to atmosphere, e.g. connection to a existing duct system. Only available for FC 50 / FHC 50



DOME HOOD

Part.nr:

MEK 350-50 (Ø50 mm)

MEK 350-75 (Ø75 mm)

The clear dome hood is suitable for lighter gasses with a wider dispersal of contaminants without blocking the user's vision.



FLAT SCREEN HOOD

Part.nr:

MEPH 300-50 (Ø50 mm)

MEPH 300-75 (Ø75 mm)

The flat screen hood is designed to maximise the working area without obscuring the object from the user. The flat screen hood gives the best suction effect for table and bench tasks.



SQUARE HOOD

Part.nr:

MESH 350-50 (Ø50 mm)

MESH 350-75 (Ø75 mm)

The square hood is suitable for placing above gases with a high lift, or adjacent to the work surface for contaminants with no lift or low lift – all this without interfering with the work.



FLEXIBLE SUCTION NOZZLE

Part.nr:

MEFS 600-50 (Ø50 mm)

MEFS 600-75 (Ø75 mm)

The flexible suction nozzle is designed to maximise ease of movement without sacrificing air flow efficiency. Available in the ESD version only.



Health aspects

Particles from fume and dust.

Some particles from substances such as quartz can enter and remain in the lungs. Other particles can enter the blood stream and are transported to other organs and areas of the body. If the fume for instance includes lead the particles can enter the alveolus in the lungs and then transferred to the blood stream and can be transported to the skeleton.

Vapour from solvents (VOC).

Nearly all solvents are Volatile Organic Compounds or liquids. They are used in a many every day applications, such as component cleaning, degreasing, and to dissolve products that are not able to be dissolved in water. They also form the drying agent in products such as adhesives, paints, and varnishes. Vapours from these solvents typically have a narcotic effect that courses tiredness, dizziness and intoxication. Vapour and gases from solvents can also enter your body by the respiratory system and then spread to the brain and liver. The vapours from solvents are also irritating your eyes and respiratory system.

Save your lungs!

By using a suitable and effective extraction solution combined with an efficient filter system, you can reduce or even eliminate the risk of working with airborne hazards.

Particles smaller than 5 µm enter your lungs through the alveolus and can harm you in a many ways. It is best practice to prevent the airborne hazard entering the breathing zone by capturing it at source.

Application guide line

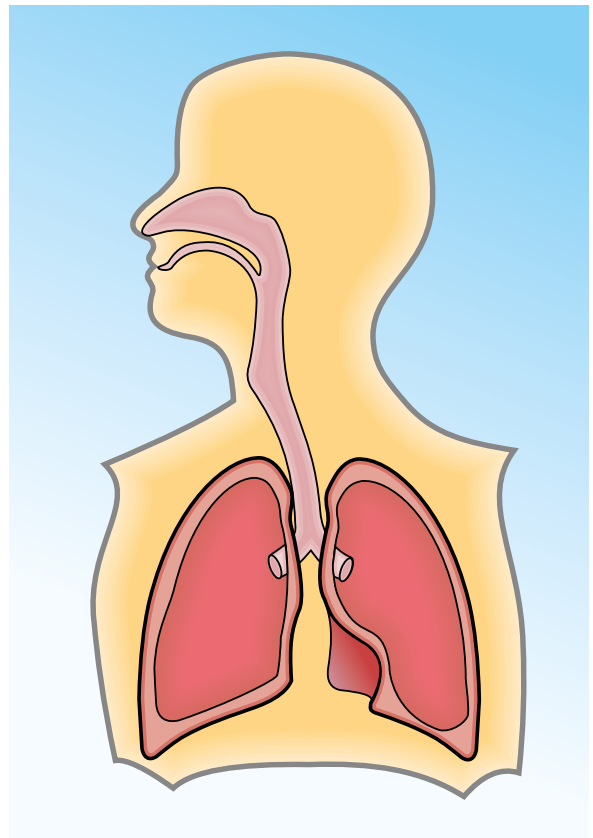

Type of application	Hazard substances	Rec. LFK	Rec. filter
Soldering (Electronic)	Resin, Lead, Terpene, Limonene, Borneol, Isosyanates	LFK 150/250/450	Particle/Gas
Solder Pot	Resin, Lead, Terpene	LFK 175/275	Particle/Gas
Gluing / Bonding	VOC1, Methylmetacrylate (MMA), Toluene, Ethyl-2-cyanoacrylate, Tetrahydrofuran, Cyklohexanone	LFK 150/175	Gas
Screen printing	Methyl ethyl ketone (MEK), Toluene	LFK 150/250	Gas
Cleaning / degreasing	Acetone, Toluene, MEK, VOCs1	LFK 350 C	Gas
Dental Lab	Dust, MMA	LFK 175/275	Particle/Gas
Nail salon	2-Hydroxyethyl methacrylate (HEMA), MMA, Acetone, buffing dust	LFK 150	Particle/Gas
Laser cutting	Dust, metal particulate, odour	LFK 150/450	Particle/Gas
Moulding	Epoxi, Styrene	LFK 175/275	Gas
Conservation	VOCs1	LFK 175/275/LFK 350C	Gas
Precision TIG welding	Welding fume, Gases, Ozone	LFK 175/275	Particle/Gas
Stained Glass working	Lead fume, VOCs1	LFK 175/275	Particle/Gas
Botany research	VOCs1	LFK 175/275	Gas
Sculpturing	VOCs1, silica dust, sealants	LFK 150/175/275	Particle/Gas

1 VOC (Volatile Organic compounds)

FUMEX® LF

FF 100
(mm)

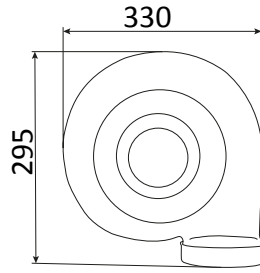
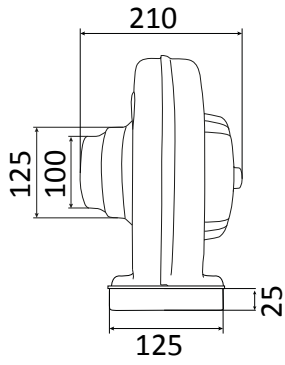

LF VK

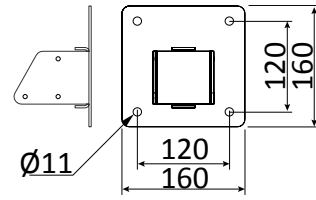

FF 100 +
FC/FHC 50
(mm)

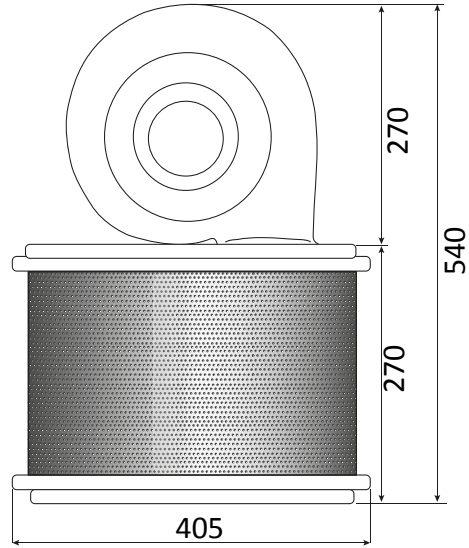
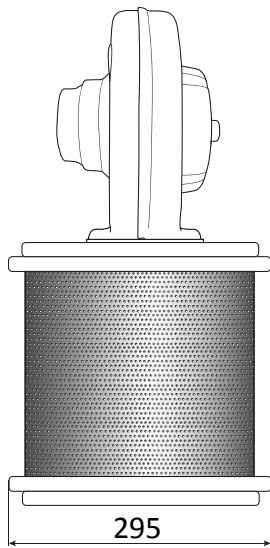

FF 100 +
FC/FHC 100
(mm)

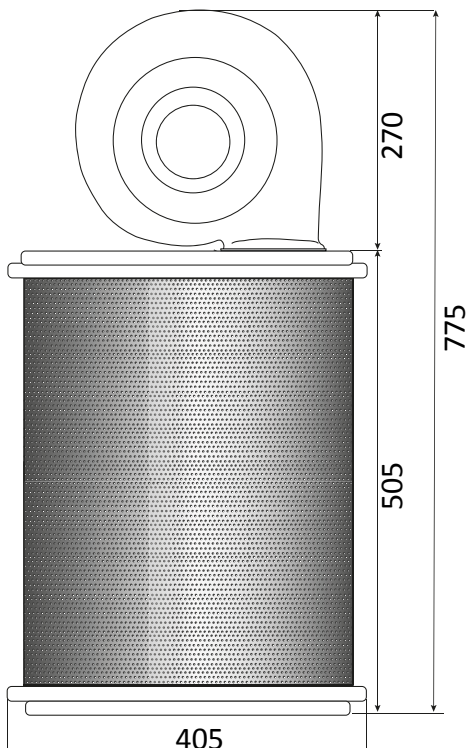
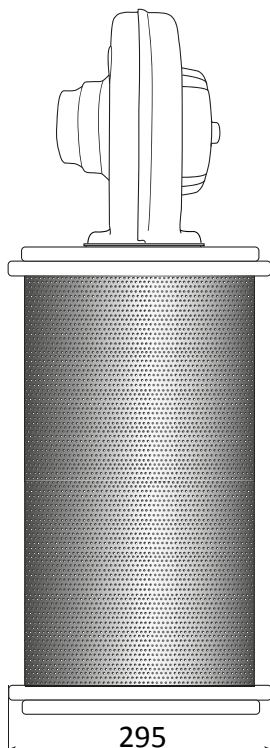

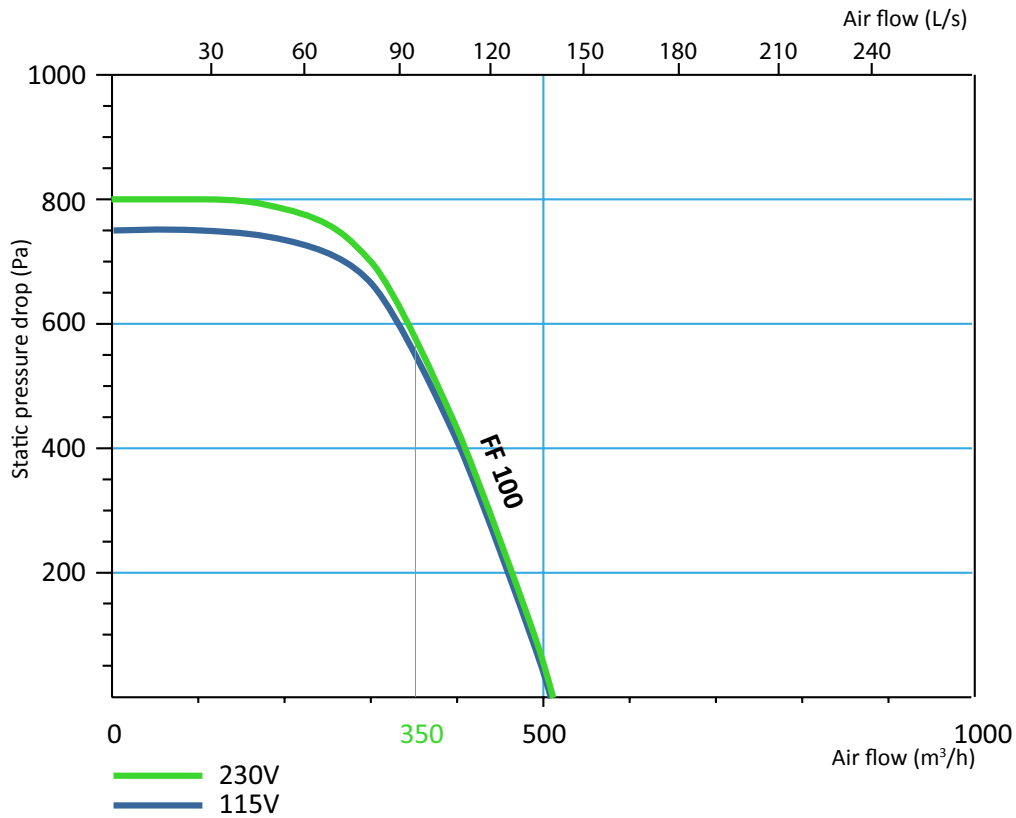

Performance LF 100

Airflow	0-350 m³/h (max)
Motor 230V	165 W, 200-240V / 50-60 Hz
Motor 115V	145 W, 100-130V / 50-60 Hz
Weight	3,2 kg
Noise level (1 m)	60 dB(A)
Max temperature	50°C

FUMEX®

Verkstadvägen 2, 931 61 SKELLEFTEÅ
 Skellefteå : Tel : 0910-361 80, Fax 0910-130 22
www.fumex.com info@fumex.se